



VISTAFOLIA[®]

ARTIFICIAL GREEN WALLS

TECHNICAL & INSTALLATION GUIDE

EXPLORE VISTAFOLIA®

The market leader in artificial green walls



Where horticultural limits are reached, our artificial green walls are the market-leading solution for spaces where plants cannot grow.

Our green walls transcend the need for light and water and are at home anywhere your imagination takes them.

Manufacturing our Vistafolia® Panels to the highest standards in our own facility, we have faithfully replicated nature's beauty using colours and forms virtually indistinguishable from real plants.

VISTAFOLIA LTD. BRING WALLS TO LIFE

Contents

	ABOUT
P. 4-5	A personal touch
P. 6-7	Research and Development
P. 8-9	The Vistafolia® difference
	TECHNICAL
P. 10	Why specify Vistafolia®?
P. 11	As simple as 1, 2, 3
P. 12	Unique 3-panel solution
P. 13-15	Technical datasheet
P. 16	Colour Boxes
P. 17	Texture Boxes
P. 18-19	Colour Box Preparation
P. 20	Panel profile
P. 21	How to measure
P. 22	How to measure for cut-offs
P. 23	Fixing system
	INSTALLATION
P. 24	Installation methods
P. 25	Installation tools
P. 26	6-step installation
P. 27	Panel preparation
P. 28	Fixing layout and gaps
P. 29	Panel layout
P. 30-32	Cutting guide
P. 33-36	Other installation methods
P. 37	Maintenance and cleaning guide

PRODUCED BY:
VISTAFOLIA® CREATIVE TEAM

ALL RIGHTS RESERVED.
NO PART OF THIS PUBLICATION MAY BE USED
IN ANY FORM OR MEANS WITHOUT THE PRIOR
WRITTEN CONSENT OF VISTAFOLIA LTD.

PRINTED IN THE UK
COPYRIGHT © 2020, VISTAFOLIA LIMITED.

**IF YOU HAVE ANY QUESTIONS
PLEASE CONTACT:**
UNIT 6 TRADE CITY FRIMLEY,
LYON WAY, FRIMLEY, CAMBERLEY
GU16 7AL UNITED KINGDOM
TEL +44 (0)20 7385 1020



A personal touch

Paul Alder leads Vistafolia® and has 25 years' experience in the landscape industry. He has won multiple awards including 12 national awards, 5 Chelsea medals including the highly coveted Gold, and a Gold medal at Hampton Court Flower Show.



"As a multi-award winning horticulturalist with 25 years' experience of building gardens for prestigious commercial and residential projects, I realised there is a demand for a flexible system that creates the look of a beautiful vertical garden wall planting without the hassle of using real plants that require natural light and ongoing maintenance."

Vistafolia® is not simply a more cost-effective and zero-maintenance alternative to a real green wall (although both these statements are true). Vistafolia® was created to solve the problem of greening spaces where real plants cannot grow.

Our panel system was created to meet the demands of designers and architects, as well as the general public who were struggling with the installation, ongoing maintenance and high cost of growing real plants vertically.

We constantly innovate to ensure that our products are an exciting blend of high style and simplicity of function. To offer as many options as possible, our designed solutions to practical greening are exceptionally customisable, allowing customers to refresh their surroundings in their own unique way.



RESEARCH AND DEVELOPMENT

COMMIT US TO EXCELLENCE

Our success depends on innovation, which means constantly improving on product design and durability, anticipating new needs for natural-looking environments and creating seamless and better interactions between our green walls and our customers.

Our highly experienced and dedicated team are committed to making the whole world beautiful, one panel at a time. Their passion, skills and knowledge are central to the success of the company.

Copyright © 2020, Vistafolia Ltd.



WHERE CREATIVE ENERGY RUNS HIGH

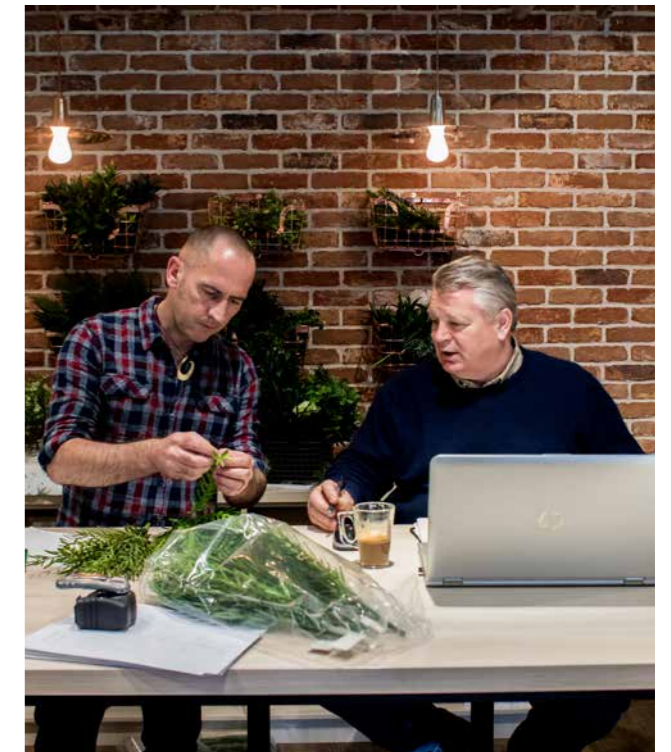

Our Vistafolia® Research and Development Centre in Surrey, United Kingdom, is a multi-purpose facility for product design and testing, training, distribution and customer engagement.

Copyright © 2020, Vistafolia Ltd.

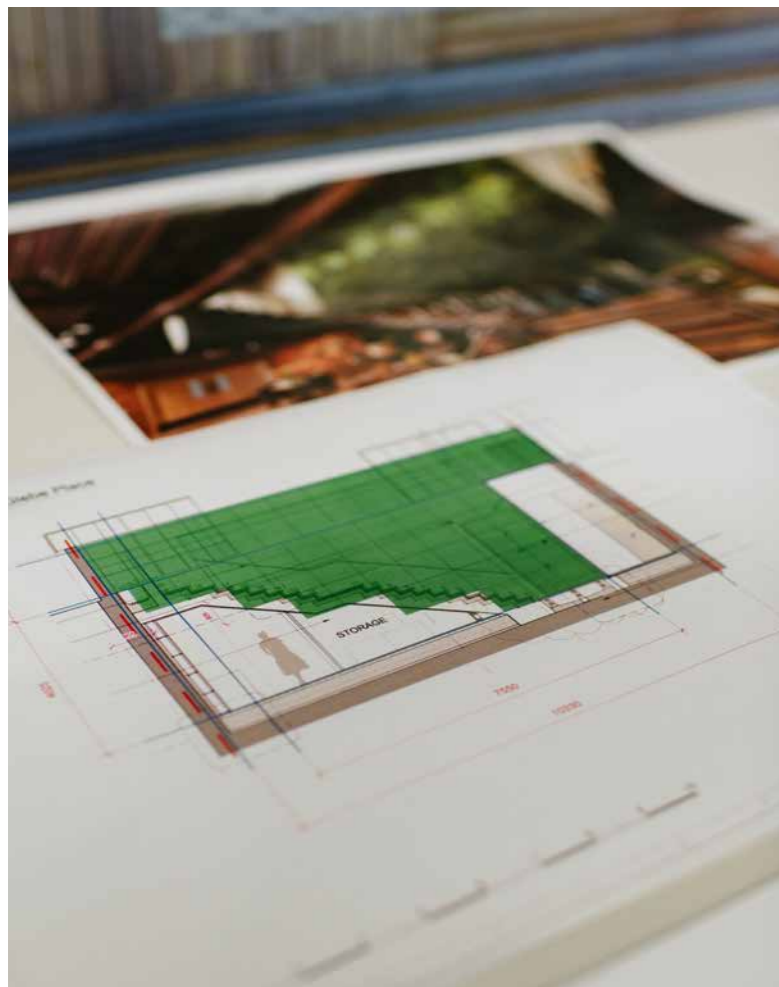

THE VISTAFOLIA® DIFFERENCE



Our London-based design team combine over 25 years of design and landscaping practice and a love of horticulture to make the Vistafolia® range the best artificial greening solutions for interior and exterior spaces in the world.

Vistafolia® designers work hard to capture the exact colours, shadings, dimensions and movement of real plants.

Our meticulous workmanship comes from a deep appreciation of nature. The splendour of creation inspires us to bring every leaf on our panels to life, faithfully replicating its vibrant colours, elegant shapes and mesmerising movements.

While our Vistafolia® range is engineered with rigorous technical precision, we also see ourselves as artisans who work with our hands to create beautiful and functional decor that pleases the senses.

Copyright © 2020, Vistafolia Ltd.

CRAFTED WITH CARE



UV-IFR TECHNOLOGY

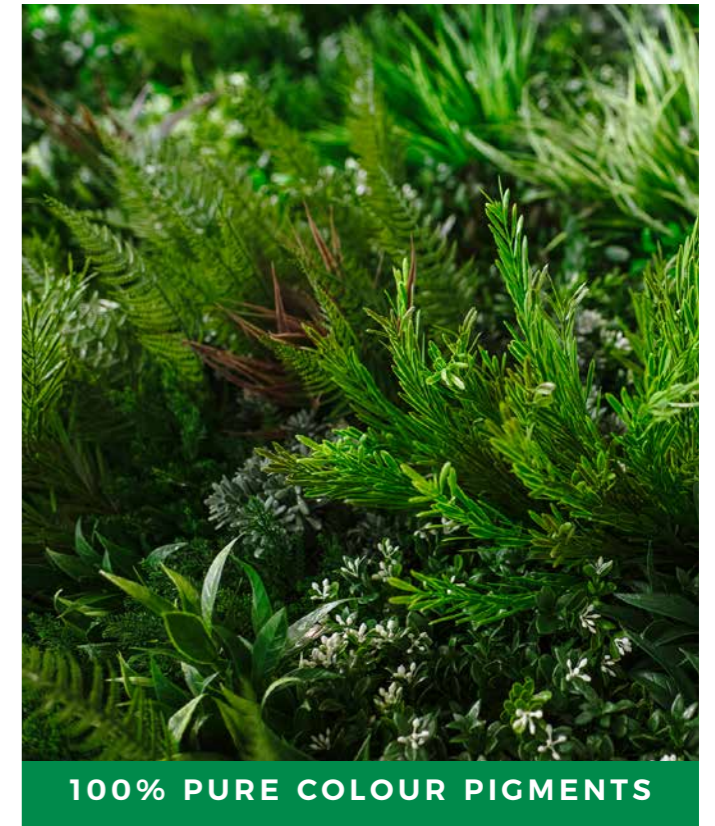

100% PURE COLOUR PIGMENTS



ULTRA-REALISTIC LOOK

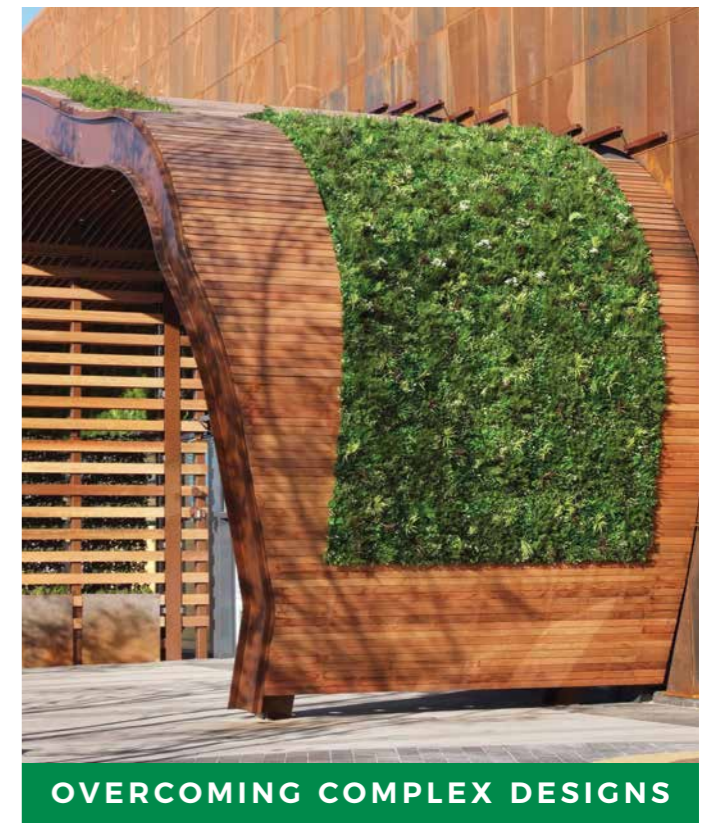

OVERCOMING COMPLEX DESIGNS

Copyright © 2020, Vistafolia Ltd.

VISTAFOLIA LTD. BRING WALLS TO LIFE

WHY SPECIFY VISTAFOLIA®?

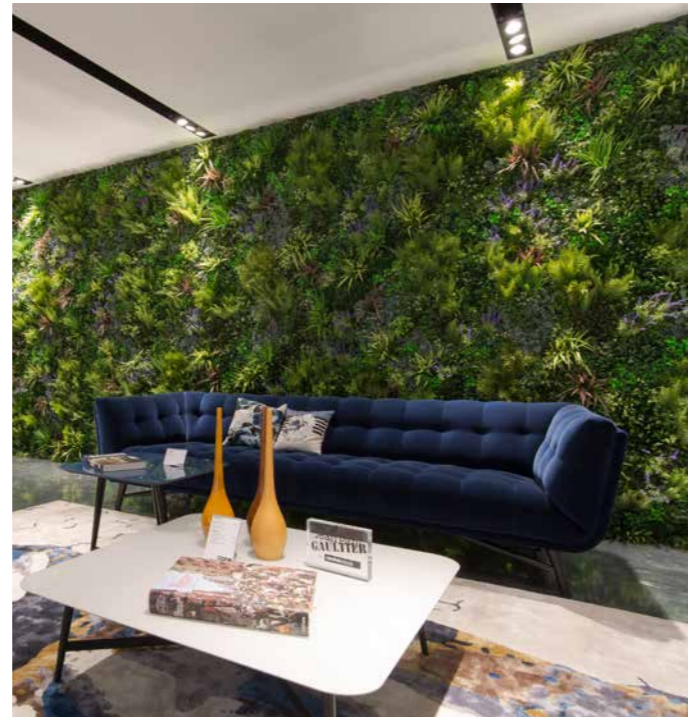

The Vistafolia® system has been rigorously tested and installed in a wide variety of challenging environments, both internal and external. It is quick and easy to install, and requires low maintenance.

HIGHEST STANDARDS & PERFORMANCE

- Best green wall solution available
- Most realistic plants in the market
- Truly unique designs
- Easily customised to any style
- Hassle free & easy install
- Instant feature wall – all year round
- Suitable for all environments
- Lightweight system
- Allows for ambient noise reduction
- Low maintenance

TRIED & TESTED

- 5 years R&D development
- 3-panel solution
- Supplied as 80 cm x 80 cm panels
- Approx. 7 kg per panel
- Patent pending No. GB2547747A
- UV and Fire Rated with certificates
- UV solar weather tested foliage to BS EN ISO 4892-2:2013
- Fire test certification BS EN ISO 13501-1:2007+A1:2009
- Freeze and thaw tested
- 5 year UK warranty

AS SIMPLE AS 1, 2, 3



The key component of Vistafolia®'s unique artificial wall solution is the Vistafolia® Panel, which is used to create the stunning vertical gardens.



1 VISTAFOLIA® PANEL

Each basic pack contains 3 Vistafolia® Panels (1xA, 1xB and 1xC).

One pack provides 1.92 m of coverage (so if, for example, you have a 2.4 m x 2.4 m area, you will require three boxes).



2 COLOUR & TEXTURE BOXES



Colour Boxes and Texture Boxes contain individual flowers and foliage that can be slotted and secured into your Vistafolia® Panels to customise the look of your green wall.

3 FIXINGS



Available in two convenient packs containing either 12 or 120 fixings. Each Vistafolia® Panel requires a minimum of 4 fixings.

UNIQUE 3-PANEL SOLUTION

THE FUTURE OF ARTIFICIAL GREEN WALLS IS HERE

The Vistafolia® solution uses a unique three-panel system to create a totally natural look without repetition or visible joins. Each Vistafolia® Panel pack comes with three panels (A, B and C) that combine for a seamless effect.

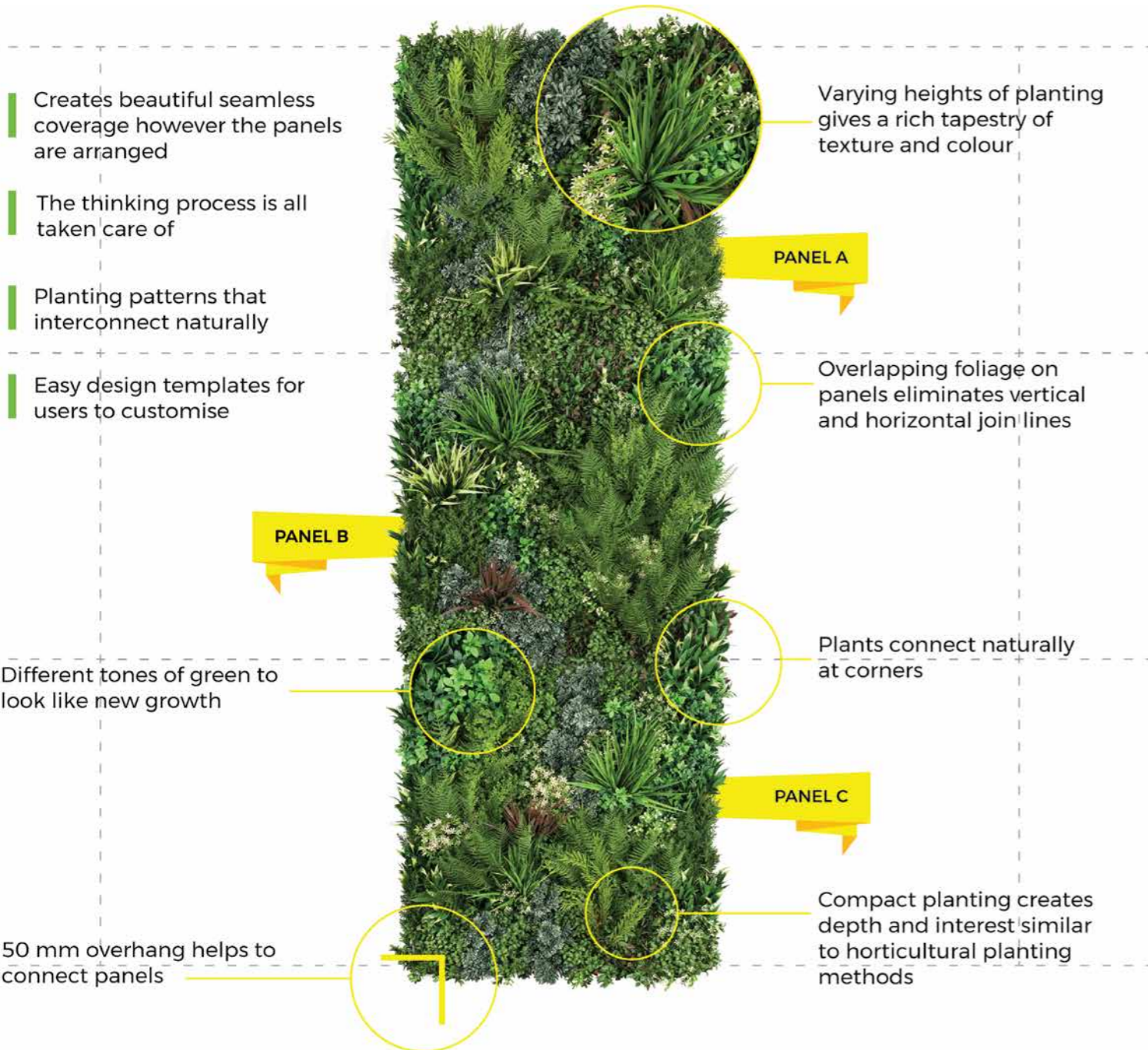

Vistafolia®'s lush artificial green wall system panels have been designed to create a beautiful green environment with a realistic effect even in the most inhospitable planting locations.

VISTAFOLIA® PANELS



PRODUCT DESCRIPTION

The standard size panel comprises UV Stabilised & Fire Rated artificial foliage fixed to a powder coated mild steel grid.

FEATURES

- Three-panel system prevents repetition in planting and removes join lines
- Durable panels manufactured to ISO 9001
- UV & Fire Rated with test certificates
- REACH Compliant
- Quick and easy installation
- Sixteen different plant varieties
- Customisable with a range of Colour & Texture Boxes

Quality Standards / Certification:

UV test: BS EN ISO 4892-2: 2013 - 'Plastics - Methods of Exposure to Laboratory Light Sources - Xenon-arc lamps.

Reaction to fire classification: B-s1, d0. BS EN ISO 13501-1:2007+A1:2009 Fire classification of construction products and building elements. Part 1: Classification using data from reaction to fire tests. Test to flammability UL94HB classified HB.

Freeze/Thaw test: MIL-STD-810G Method 524.

TECHNICAL SPECIFICATIONS

Standard Size Panel	Height: 800 mm Width: 800 mm Depth: up to 200 mm
Coverage	1 Panel = 0.64 sqm
Weight	Approx. 7 kg per panel
Distribution	72 plants per panel
Colour Reference	Mixed colours
Manufacturing process	Injection moulded polyethylene / Foliage fixed to the grid manually
Packing	Box of three panels A,B,C
Warranty	5 year in the UK



UV-IFR Technology



Quality Standard



Tested & Certified



5 Year UK Warranty



Low Maintenance



Recyclable*
*Check with local authority

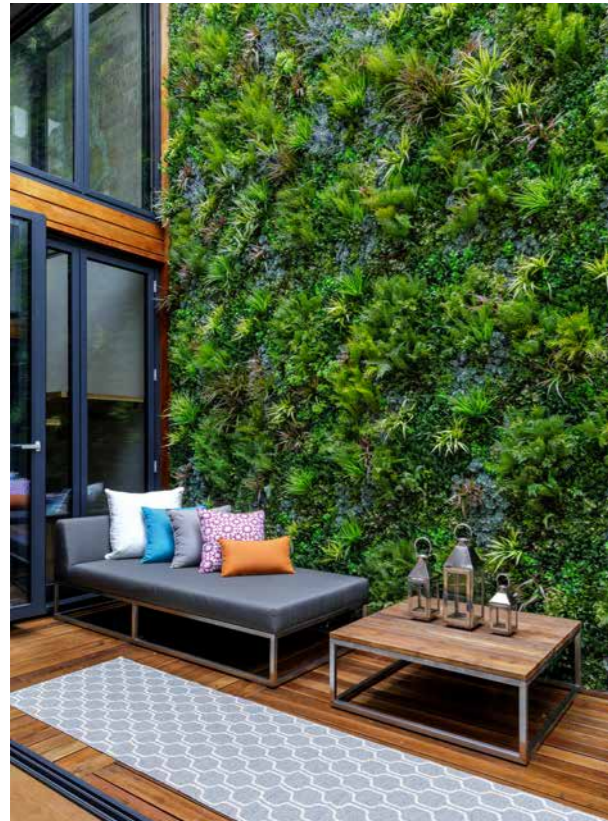

**VG
UV RATINGS**



The majority of artificial plants on the global market are made from PE (polyethylene). PE on its own is susceptible to degradation from UV light. We add UV stabilising additives directly into the master batch to slow the molecular break down of the polymers. These absorb the UV rays and protect the colour and structure of each plant.

Our foliage is tested in xenon arc chambers for 3000 hours (equivalent to 3 years) at Mediterranean irradiance levels. These accelerated test chambers mimic the ultraviolet light levels found around the globe and test the ability of our foliage to not fade or become brittle.

The test results refer back to the grey scale which is a visual test of changes in colour or hue of the material. "Grey scale consists of pairs of standard grey chips representing progressive differences in lightness or contrast - zero or no difference for grade 5 to maximum difference for grade 1. It is generally used for evaluating changes in the colour of textiles while carrying out colour-fastness tests."

Here at Vistafolia® we test and retest to ensure the combination or UV tolerant additives are balanced and perform to there optimum capacity.

Box 1: The Grey Scale is used for determining changes in colour
This scale consists of five pairs of non-glossy grey colour chips, which illustrate the perceived colour differences corresponding to the ratings

Key to Grey Scale	
Rating 5	No change in appearance
Rating 4	Slight change in appearance
Rating 3	Moderate change in appearance
Rating 2	Marked change in appearance
Rating 1	Very marked change in appearance



**REACTION TO FIRE
CLASSIFICATION**



At Vistafolia® we pride ourselves not only on the realism of our foliage but also the research and development of stronger safer materials. We now boast a market-leading fire classification that meets the high demands set in the building industry regarding fire safety.

Vistafolia®'s range of foliage is tested as per the criteria set out in EN ISO 13501-1:2007+A1:2009 Fire classification of construction products and building elements. Not only is our foliage tested to prove its fire retardancy but also for its smoke output.

TESTING METHODS

The methods that the Vistafolia® range is tested to are:

- EN 13823:2010+A1 Reaction to fire tests for building products - Building products excluding floorings exposed to the thermal attack by a single burning item.
- ISO 11925-2:2010 Reaction to fire tests – Ignitability of products subjected to direct impingement of flame – Part 2: Single-flame source test.

TEST RESULT AND CLASSIFICATION: B-s1,d0

Fire behaviour	Smoke production			Flaming droplets	
B	-	s	1	d	0

Class	Test method(s)	Classification criteria	Additional classification
B	EN 13823 and	FIGRA ≤ 120 W/s and LFS < edge of specimen and THR _{600s} ≤ 7,5MJ	Smoke production ^f and Flaming droplets/particles ^g
	EN ISO 11925-2 ¹ : Exposure=30s	F _s ≤ 150mm within 60s	

These tests measure the flame spread and propagation of a fire and measures the smoke levels released during a test.

This allows our clients peace of mind, safe in the knowledge that our product will meet the demands of the increasingly stringent requirements of the fire safety industry.

PERSONALISE WITH COLOUR BOXES

Colour Box packs contain individual plants that can be tucked into the Vistafolia® panels to customise the look. Each box of additional foliage contains enough plants for around 10 panels and gives you the tools you need to create a truly bespoke finish.



**Soft Lavender
Colour Box**

Cascading greens blended with stunning blue lavender and blossoms.

**Spring Pink
Colour Box**

A timeless combination of elegant pink flowers and earthy green plants.



**Delicate White
Colour Box**

Lovely mix of summer blossoms dotted with delicate white flowers.



**Forest Flame
Colour Box**

Bold red-flowering Pieris accompanied by lush green foliage.



PERSONALISE WITH TEXTURE BOXES

Texture Box packs contain individual plants that can be tucked into the Vistafolia® panels to customise the look. Each box of additional foliage contains enough plants for around 10 panels and gives you the tools you need to create a truly bespoke finish.



**Lush Green
Texture Box**

A tumble of wild grasses and earthy ferns merged with green-fused and delicate flowers.

**Large Grasses
Texture Box**

A selection of large 18" grasses, in colourful shades of green and burgundy.



**Trailing Ivy
Texture Box**

Trailing ivy for a trailing finish that can be used to add volume, or even as a standalone plant for baskets and planters

**Trailing Buxus
Texture Box**

Trailing buxus for a trailing finish that looks at home on the panel, or adding an extra dimension to an indoor or outdoor display.



1 CHOOSE THE COLOUR



Vistafolia® offers endless ways to customise your wall with a vibrant selection of natural hues.



2 PREPARE TO BE CREATIVE, OR LET US DO IT FOR YOU

Each box of additional foliage contains enough plants for around 10 panels and gives you the tools you need to create a truly bespoke finish.

ONE BOX PER 10 PANELS



3 SLOT THE PLANTS IN



The plants are inserted once the panels have been installed

Create your own style by mixing boxes together, giving bolder groups of plants and drifts of flowers. Use these plants, as you please, simply slotting them into the Vistafolia® Panel where you want them.



4 ATTACH THEM TO THE WALL

The plants are held in place with cable ties (included). There is a box for everyone and each variety serves its own unique purpose.

There is a box for everyone and each variety serves its own unique purpose.



PANEL PROFILE

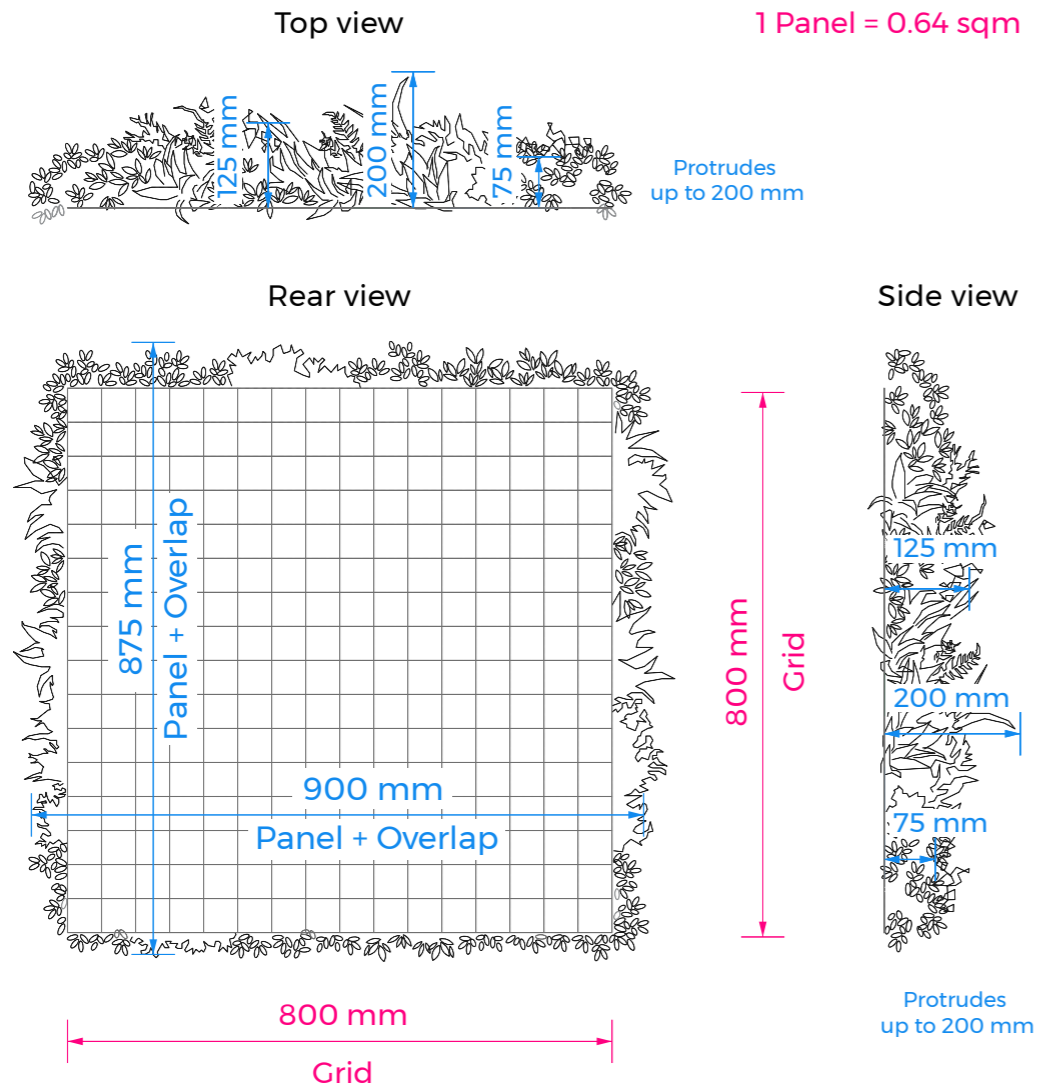

The Vistafolia® Panel was designed with a small allocation of ‘planting overlap’ to allow for seamless installation of multiple panels. The top overlap is slightly greater than the bottom one whereas the side overlaps are the same. The overlap also serves to disguise the grid that holds the plants.

HOW TO MEASURE

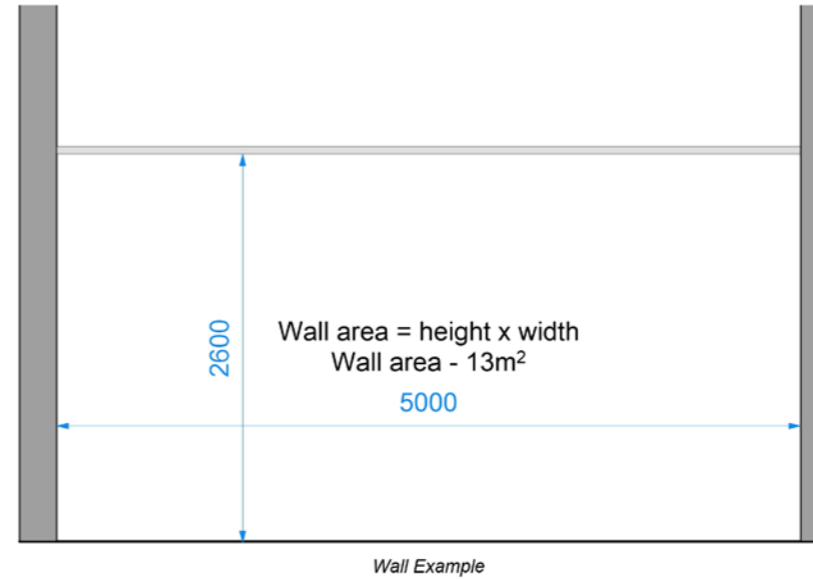

1. MEASURE THE WALL

Height and width.

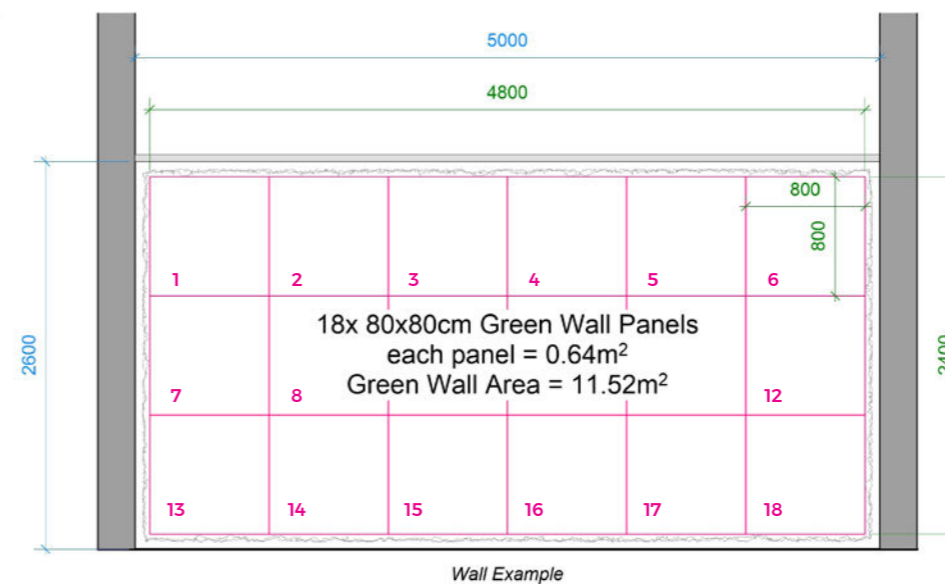

2. COUNT THE PANELS

Count the number of complete panels that you will need. You may need to estimate for any extra panels to fill to the edge of your space.

For how to measure for cut-off panels, see guide overleaf.

HOW TO MEASURE FOR CUT-OFFS

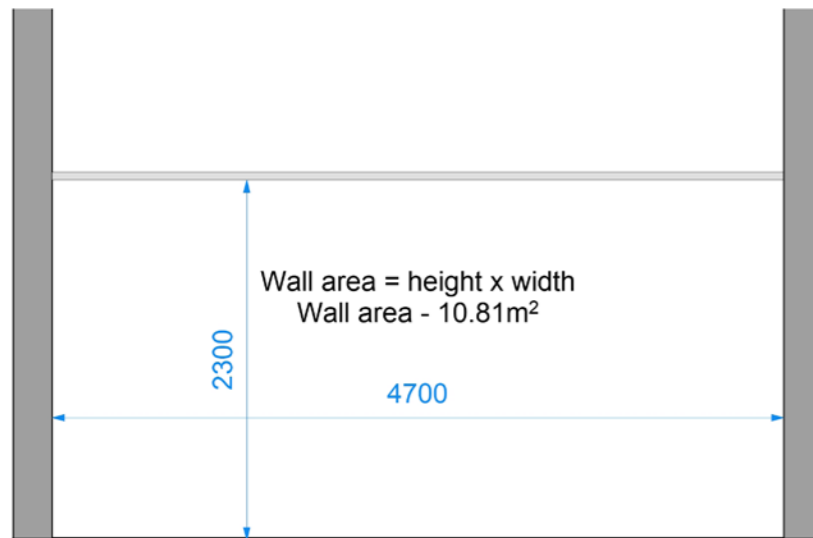

Wall Example

1. MEASURE THE WALL

Height and width.



2. ESTIMATE CUT PANELS

If panels will not fit your space exactly, allow for extra panels which can be cut to size using this guide. See page 28.

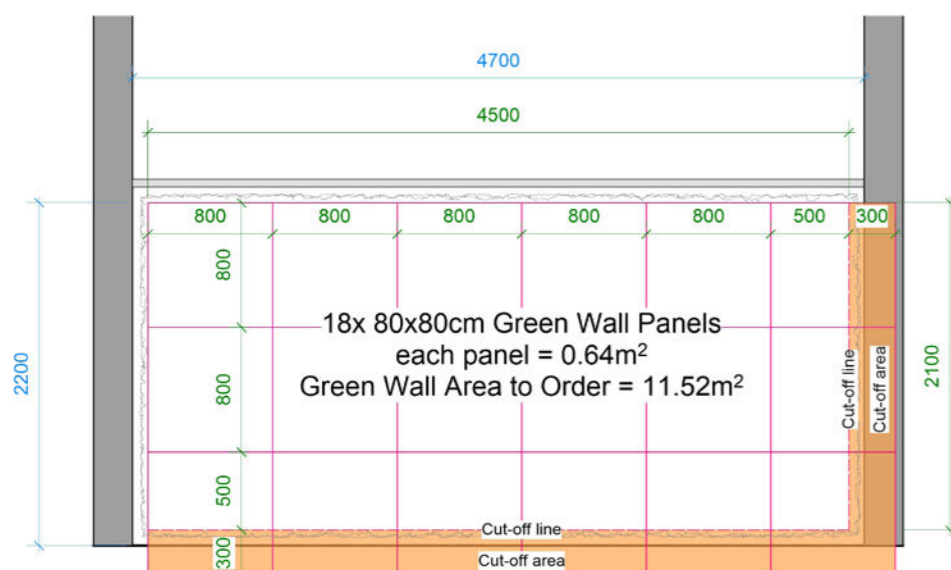

Wall Example

FIXING SYSTEM

The Vistafolia® Fixing System has been specifically designed to securely hold panels in the optimum position and to give the best result in a wide variety of applications.

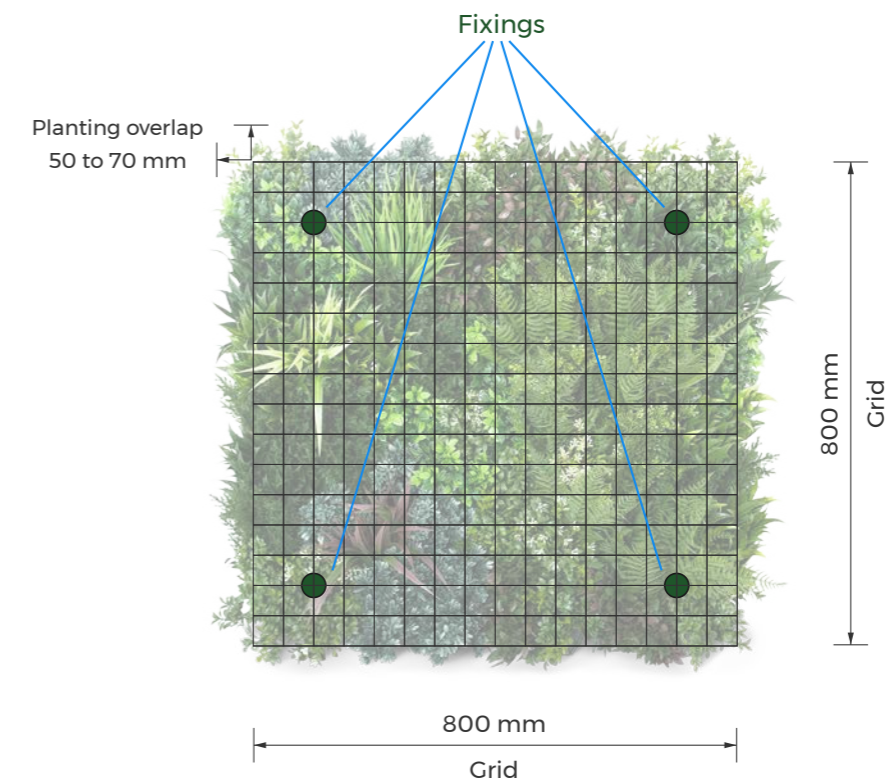

Use our fixings for a neat and reliable installation. Each Vistafolia® Panel requires a minimum of 4 fixings. The fixings can be attached to the vertical or horizontal wires or placed at the joins.

FIXINGS



- Can be attached to most surfaces simply and quickly using standard tools.
- Create a gap between the panel and the mounted surface to allow a free flow of air.
- Enable panels to be removed and remounted easily to allow for cleaning and maintenance.
- Available in two convenient pack sizes containing either 12 or 120 fixings.

INSTALLATION METHODS

METHOD 1:

Brick/Block wall using Vistafolia® fixing

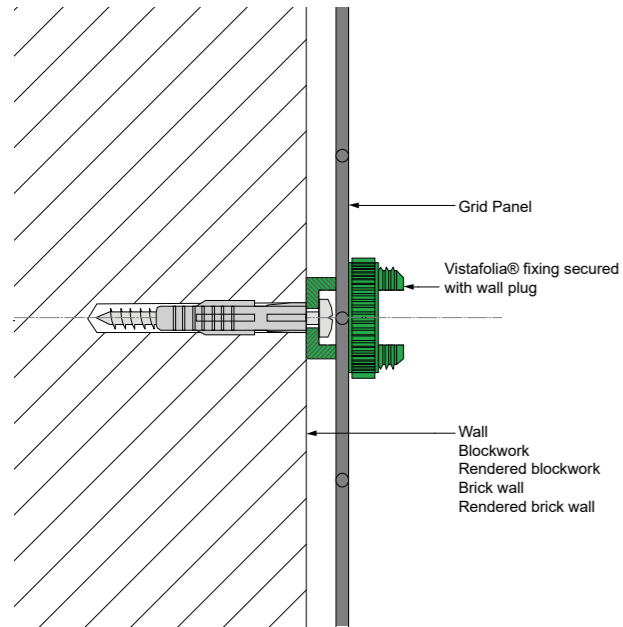

METHOD 2:

Timber frame using screw and washer

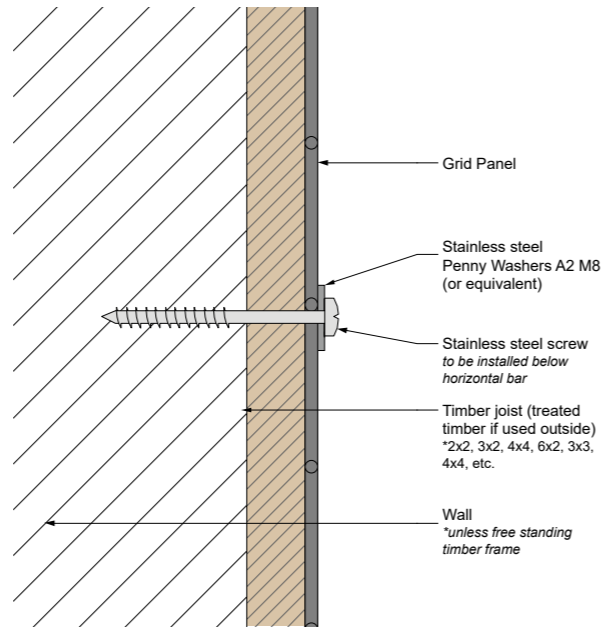

METHOD 3:

Aluminium (metal) bar

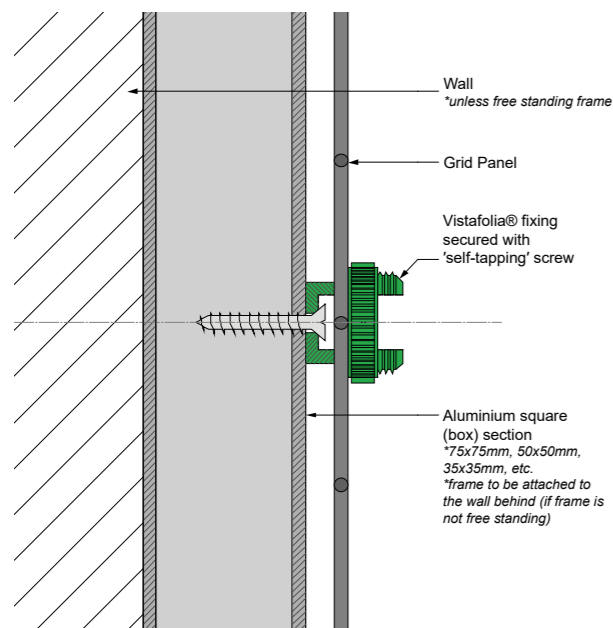

METHOD 4:

Plasterboard / Plywood board / MDF

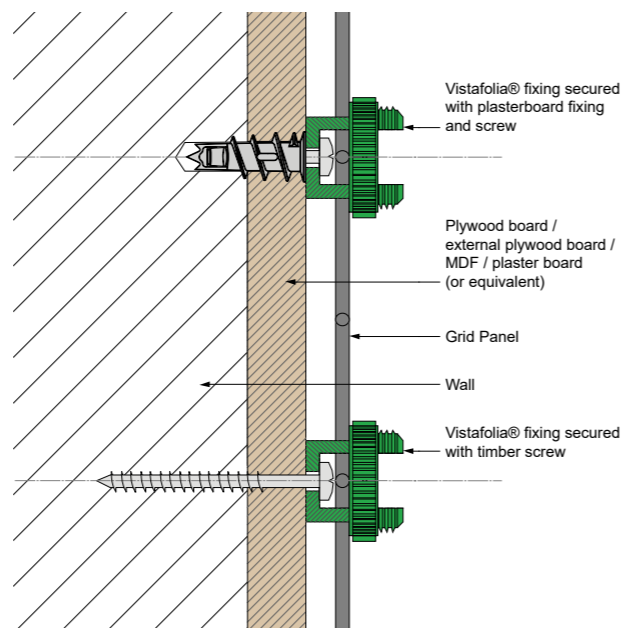

INSTALLATION TOOLS

These are the tools that you need to install Vistafolia® Panels.



Safety goggles



Tape measure



Drill



Safety gloves

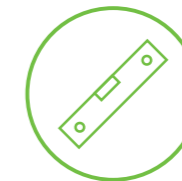

Spirit level



Rawlplugs



Ladders or mobile tower



Pencil



Screws

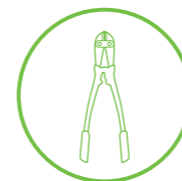

Bolt cutter



Wire cutter



Cable ties

6 EASY STEPS TO FOLLOW

PANEL PREPARATION



Measure & mark



Drill the holes



Plug & screw the fixing



Attach the panel



Secure the fixing



Ruffle & bend the foliage

PREPARING THE PANELS IS THE MOST IMPORTANT STEP IN THE INSTALLATION PROCESS



AFTER INSTALLATION

1. Install all the panels to the wall.
2. Unfold the foliage as panels will look flat and compressed.
3. Pull the larger plants away from the panel to make them stand up. Although the plants should be secure enough so as not to come loose, do not use excessive force.

NOTE: Some of the smaller leaves may come loose during preparation, this is to be expected. As extra leaves are added during the manufacturing process to compensate for any small loss, this will not affect the look of the product.

1.

Manipulate the foliage with your fingers. Pulling the plants in different directions will add to the realism and replicate natural, random growth.

2.

Once you have prepared the larger plants, do the same with the smaller ones.

3.

Repeat the same process until all panels have been taken out of the boxes or installed.

FIXING LAYOUT

MEASURE AND MARK THE HOLES IN THE WALL

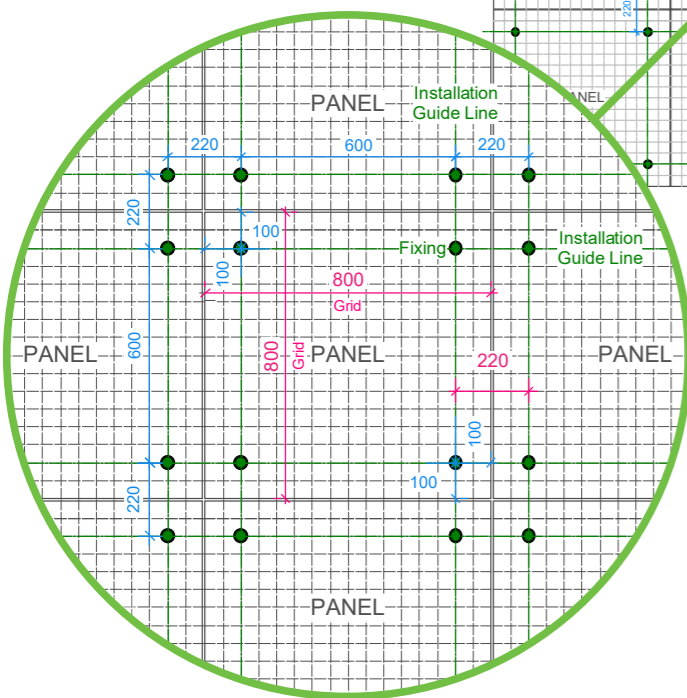
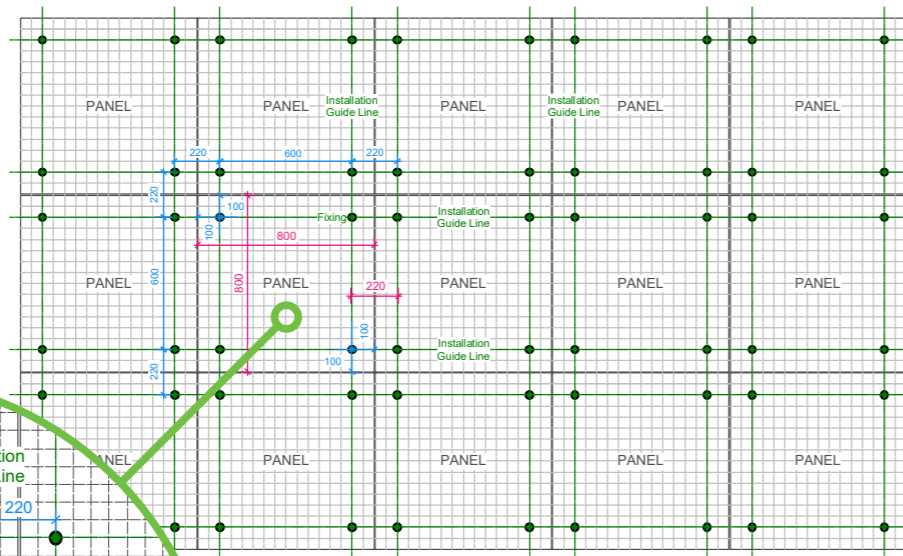

GAPS BETWEEN THE PANELS

We recommend to leave a gap between panels to allow for easier installation and to reduce bunching of foliage on joins.

The maximum gap between 2 panels can be : 20 mm = 2 cm

Gap left in the drawing = 20 mm

STEP 1

At top left of the panel, measure 100 mm down and mark this as first point.

STEP 2

Measure 600 mm across horizontally from first marked point and mark as second point.

STEP 3

Measure 600 mm down vertically from first marked point and mark as third point.

STEP 4

Measure 600 mm across from third point and mark as fourth point.

STEP 5

Measure 220 mm from point 2 and 4, which become points 1 and 3 of the second panel. This process can be continued throughout installation.



PANEL LAYOUT

Make sure you mix the panels so you don't have the same panel against to another.

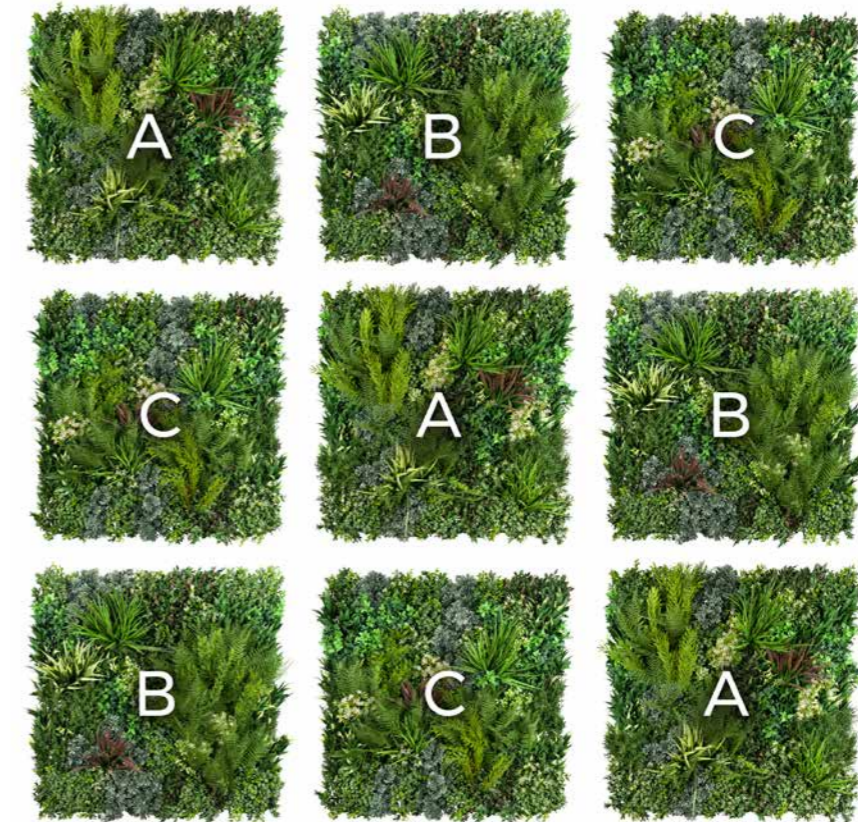

The fixing should ideally be installed on the cross joint of the grid as shown on the pictures below; however, it is possible to secure the Vistafolia® Panels with fixings on the horizontal or vertical bars, with the latter being the least recommended option.



HOW TO CUT THE GRID

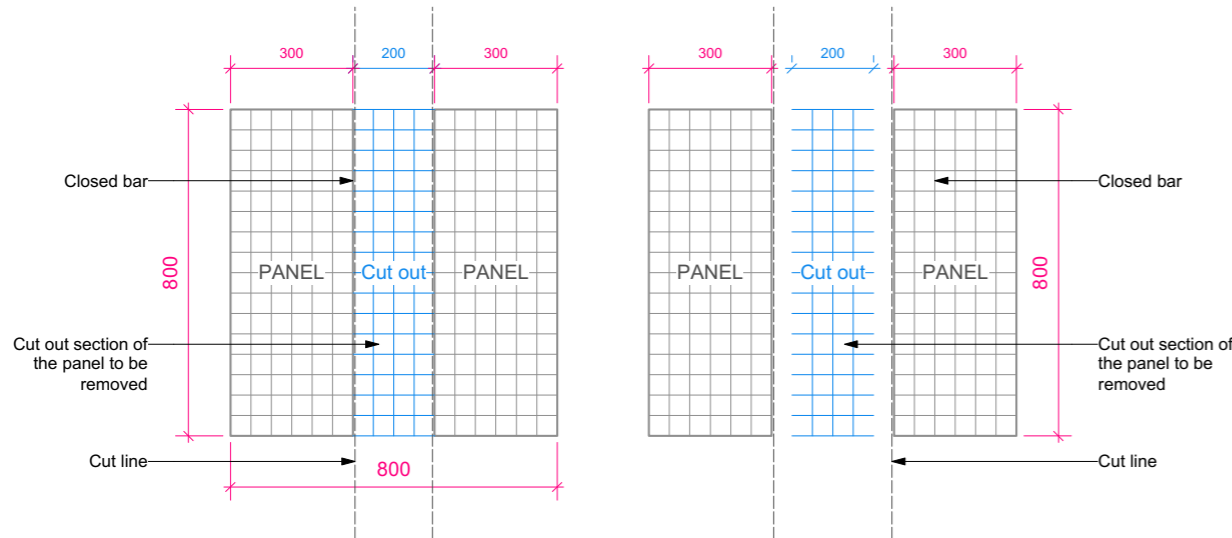

NOTE: Vistafolia® Panels are best cut using a bolt cutter. Cutting discs cause damage to foliage and the sparks may leave scorch marks and black marks. A disc cutter also leave very sharp edges on cut grids. Personal Protection Equipment is recommended to be worn prior to cutting, safety glasses and gloves as a minimum.



STEP 1
Measure carefully and mark the area to be trimmed.



STEP 2
Clip off the excess as close as possible to a grid section and separate the parts.



STEP 3
File the grid after cutting.



STEP 4
Protect cut point with metal paint.



STEP 5
Re-attach loose plants from the vertical off-cuts with cable ties.



STEP 6
Re-adjust any plants on the cut parts and fill in all the gaps with loose foliage.

CUTTING TIPS

- 1) All cut panels to finish on a **closed bar**, so the plants don't slip off.
- 2) Spare foliage from the offcuts to be re-attached to the rest of the green wall where required.
- 3) Plastic ties to be removed from the off-cut parts of the panels.
- 4) Vertical cuts are easier to make than horizontal cuts.
- 5) Horizontal cuts to be started from the top of the panels (unless otherwise required).
- 6) Always cut from the inside out.

VERTICAL CUTTING

2x sections from one panel

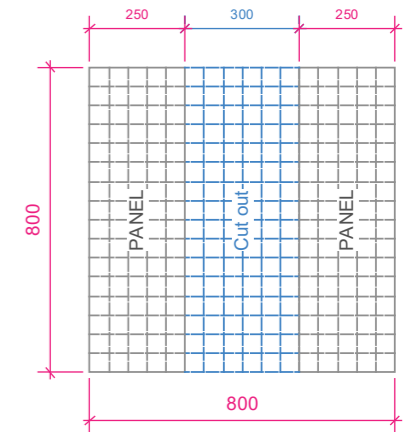
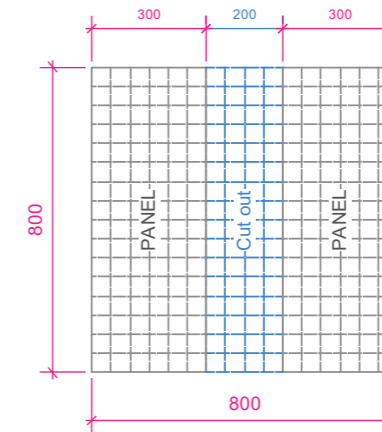
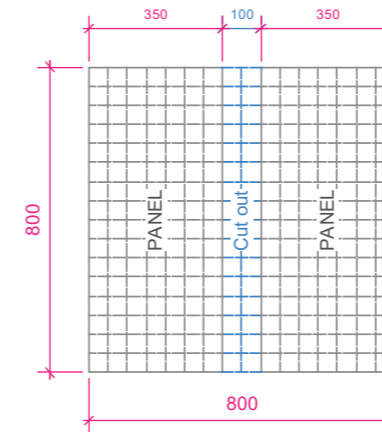

3x sections from one panel

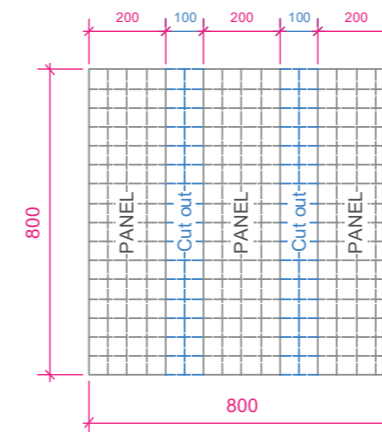

4x sections from one panel

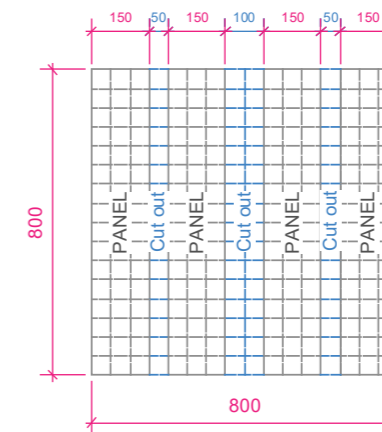

5x sections from one panel

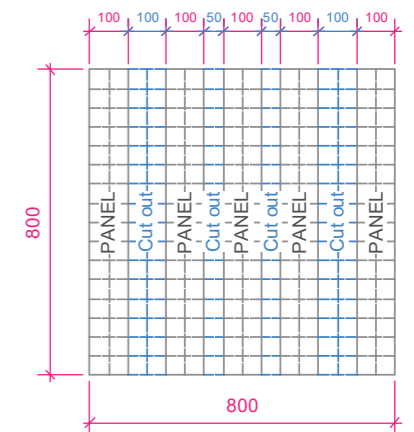

HORIZONTAL CUTTING

1x 100mm end off-cut

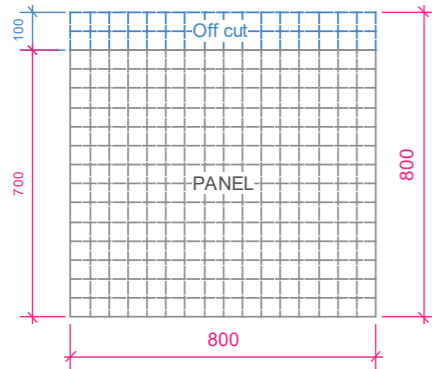

1x 150mm end off-cut

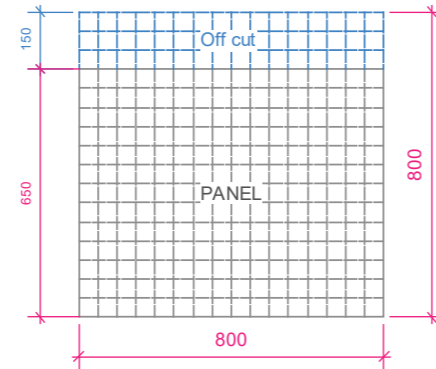

2x sections from one panel

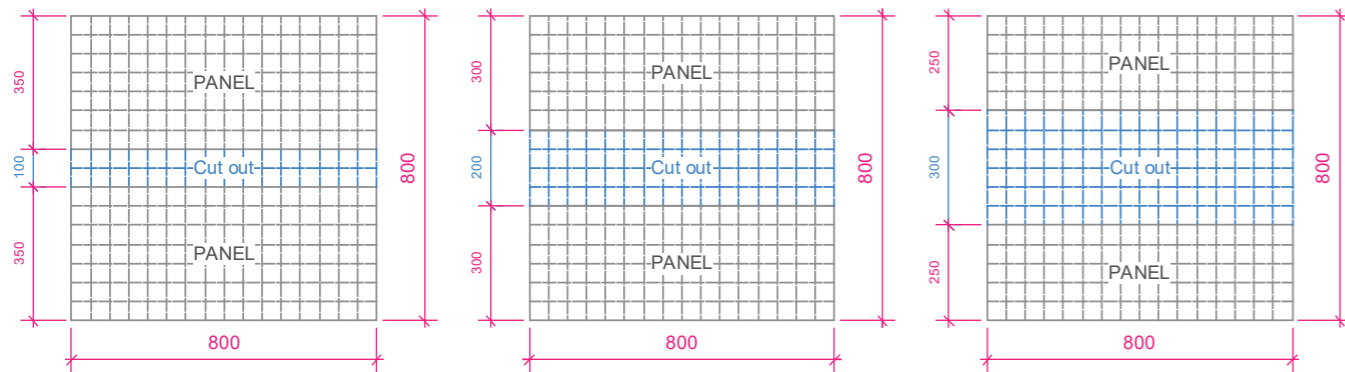

3x sections from one panel

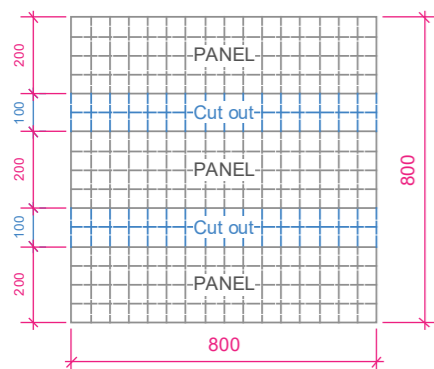

4x sections from one panel

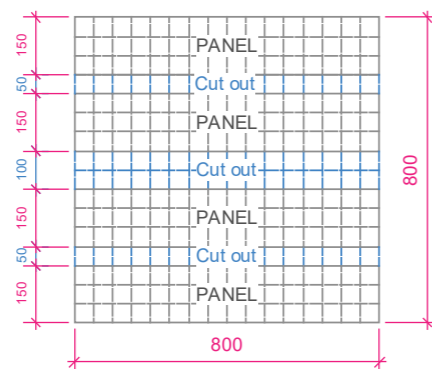

5x sections from one panel

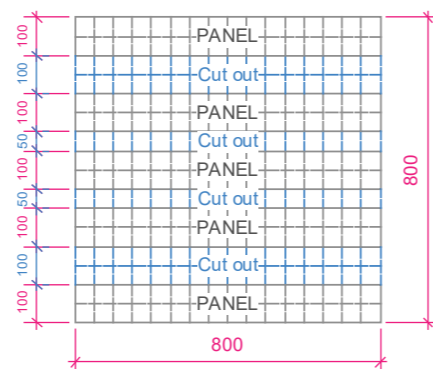

TIMBER FRAME FOR THE VISTAFOLIA® PANELS

In some cases, a timber frame needs to be arranged in order to have a fixed and sturdy base for the Vistafolia® Panels, such as:

- Existing fence is not strong enough for installation
- The existing wall or fence is uneven
- Waterproof membrane wall (note: specialist advice should be sought prior to any installation where a waterproof membrane exists. See p.34).



METAL FRAME FOR THE VISTAFOLIA® PANELS

The metal frame system needs to be arranged in a similar way to the timber frame. The main difference is timing. While the timber frame can be done by the installer/contractor on the same day of installing the Vistafolia® Panels, the metal frame needs to be fabricated prior by a professional metal fabricator which takes time since it is bespoke for each specific project.

If the panels need to be cut obliquely like on the project with the metal frame below, then we recommend to use silicone end caps to cover any sharp edges of the steel grid.

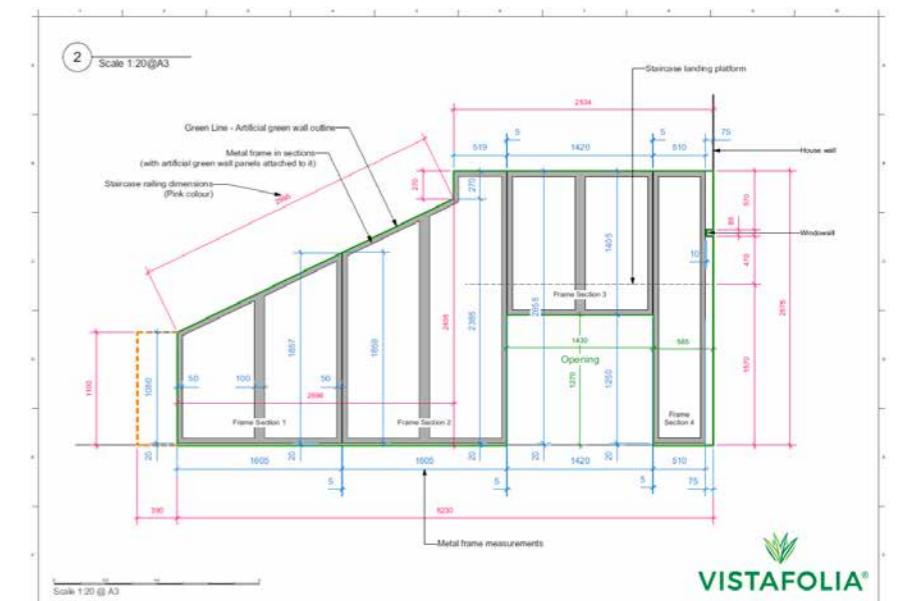

Metal frame layout plan advice: (needs to be approved by the architect)

WATERPROOF MEMBRANE FOR THE VISTAFOLIA® PANELS / DELTA PLUG LAYOUT ADVICE

ARRANGING INSTALLATION ONTO WATERPROOF MEMBRANE

- Site visit to discuss with the contractor where the green wall panels are going and advise on the location of the Delta Qwik-Seal Plugs
- Contractor to mark and install Delta Qwik-Seal Plugs onto the waterproof membrane
- Contractor to install timber frame onto the Delta Plugs
- Vistafolia® Panels can be installed onto the timber frame with simple screws and washers

The reason for fixing a baton into the membrane is that usually a separate contractor would be employed to fix through the waterproof membrane (to protect the warranty) and fixing vertical batons leaves tolerance for the final fix of the Vistafolia® Panel. It may also be possible to use an adhesive to affix timber batons. Contact Vistafolia® to discuss prior to any installation.



Delta Qwik-Seal Plug

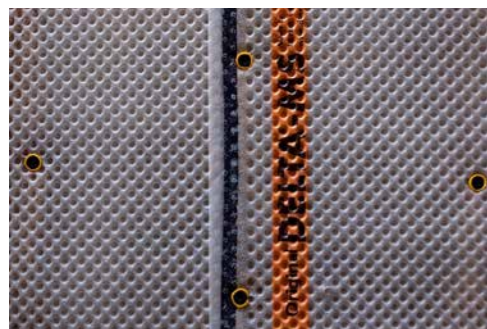

Delta Qwik-Seal Plug installed into the waterproof membrane

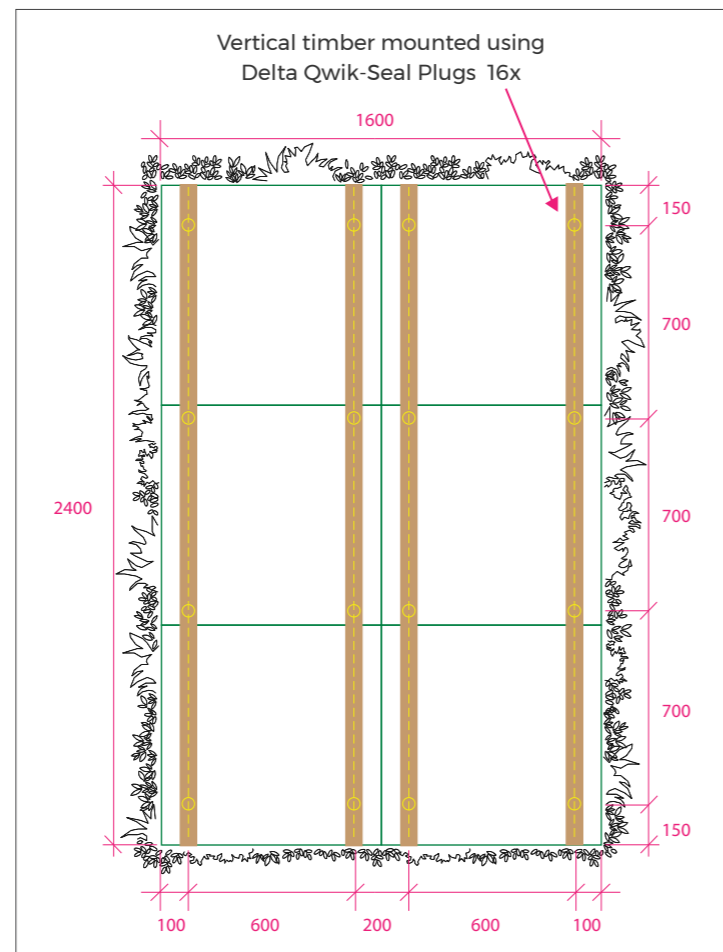

Layout plan advice for the Delta Plugs and timber

INSTALLING ONTO RAILINGS

The panels can be also installed onto metal grids or balcony railings as well. Instead of using the Vistafolia® Fixings the panels can be simply attached with high quality UV Stable (if outdoor) heavy duty cable ties.



UV Stable heavy-duty cable ties

EXAMPLE:



Metal cage before Vistafolia® Panel installation



Completed project dressed with Delicate White Colour Box prior to install due to complicated access to the wall

LOGO IN FRONT OF THE VISTAFOLIA® PANELS

For clients that would like to arrange a sign/logo in front of the Vistafolia® Wall, we usually ask to have the sign or logo company to go to site first and install the fixings of the sign/logo and any electrical cables the logo requires.

Once the sign/logo fixings + cables are in place the Vistafolia® Wall can be installed on top of it, allowing any existing fixing to go through on the Vistafolia® panel grid. After the Vistafolia® installation the sign/logo company needs to return and attach the sign/logo onto their fixings.

EXAMPLE:



Fixings of the sign – letters to be removed before panel installation



Completed Vistafolia® wall with the sign/logo on top (Dressed with Lush Green Texture Box)

MAINTENANCE AND CLEANING GUIDE

INDOOR GREEN WALLS

- Indoor Vistafolia® Green Walls require occasional, gentle cleaning with a microfibre brush to keep the panels free from dust and dirt.
- Frequency of cleaning will depend on location. Water can be used to clean the foliage using a light spray and then allowed to dry naturally without wiping the surface with a cloth.
- Do not use chemicals / detergents.

NOTES

- Do not use excessive force. This may cause damage to plants.
- Do not jet wash / vacuum.
- Occasionally foliage may come loose from the panels. This is to be expected. **Larger plants can be re-attached to the frame with cable ties.**



OUTDOOR GREEN WALLS

- Outdoor Vistafolia® Green Walls require occasional hosing to keep the plants free of dust and dirt.
- Frequency of cleaning will depend on location, areas of high traffic should be cleaned regularly.
- Do not use chemicals / detergents.

- Ladders or mobile towers should not be placed directly on the foliage or green wall as this could damage some of the delicate foliage when cleaning.



- For advice and information on keeping your Vistafolia® Artificial Green Wall in perfect condition contact us at info@vistafolia.com

All our products come with a UK 5 year warranty.
Please see our standard terms and conditions for more detail at:

www.vistafolia.com



www.vistafolia.com



HEAD OFFICE / R&D FACILITY

+44 (0)20 7385 1020

info@vistafolia.com